

## SELF-PRIMING PUMPS

### FEATURES

- Body:** Bronze Construction
- Impeller:** JABSCO Nitrile
- Shaft:** 316 Stainless Steel Impeller Sleeve over Steel Motor Shaft
- Wearplate:** Replaceable
- Shaft Seal:** Lip Type
- Ports:** 1" NPT, Internal
- Motor:** 3/4 HP, Capacitor Type, Open Drip Proof or Totally Enclosed Fan Cooled, Overload Protector, 1725 RPM, 60 Hz, Single Phase, 115/230 Vac, with 8 foot cord and plug wired for 115 Vac operation.  
**MOTOR IS NOT EXPLOSION PROOF!**
- Weight:** 35-1/2 lb (approx.) (16.1 kg)



Model 6050-Series

<b>⚠ WARNING</b>	<b>Explosion hazard. Motor can spark. Explosion &amp; death can occur. Do not use where flammable vapors are present.</b>
------------------	---

### VARIATIONS AVAILABLE

MODEL	DESCRIPTION
6050-0003	Open Drip Proof Motor Totally Enclosed Fan Cooled Motor
6050-0013	

### TYPICAL APPLICATIONS

**MARINE:** Bait Tank Circulation; Washdown, Utility Dockside Pump,

**INDUSTRIAL:** Industrial Filling Systems; Utility Shop Pump; Transfer Gum Arabic, Transfer Distilled Water; Recharge Water Softeners; Ice Water Recirculation; Hydro-static Pressure Testing; Sump Pumping.

**FOOD, BEVERAGE & DAIRY:** Circulate Cooling Water; Defrost Refrigeration Coils; Fill Drums; Wash Down Equipment and Floors; Utility Pump.

**HOME:** Fill and Empty Tubs, Pools; Empty Basements and Cesspools; Water Systems; Water Lawns and Gardens; Remove Water from Low Areas; Recharge Water Softeners.

**PLUMBING:** Empty Clogged Drains; Empty Sumps, Smks and Tubs; Pump Out Water Closets.

**FARM:** Fill Tractor Tires, Water Tanks; Pump out Silo Pits (liquid manure); Flush and Clean Animal Pens.

**CONTRACTORS:** Remove Water from Excavations; Supply Water to Mortar Boxes; Cement Mixing; Washdown Equipment.

### HEAD CAPACITY TABLE

TOTAL HEAD				CAPACITY	
PSI	kg/cm2 Water	Feet of Water	Metres of Min.	GPM	Litres per
4.3	0,3	10	3,0	23.0	87
8.7	0,6	20	6,1	22.0	83
17.3	1,2	40	12,2	19.5	74
26.0	1,8	60	18,3	15.5	59

Progressively longer life may be expected as operating pressures are reduced.

Table shows approximate Head-Flow for new pump in U.S. gallons and litres with nitrile impeller.

<b>⚠ WARNING</b>	<b>Explosion hazard. Do not use where flammable vapors are present. Do not pump solvents, thinners or gasoline. To do so can cause an explosion which can result in injury or death.</b>
------------------	--

## Jabsco Pumps 6050-0001

OPERATING INSTRUCTIONS [www.PumpAgents.com](http://www.PumpAgents.com) - Click here for Pricing and Ordering for Pumps and Parts

1. **INSTALLATION** - Pump may be mounted in any position without loss of efficiency; however, it is suggested that the pump head be down if vertical mounting is desired. The rotation of the motor shaft determines the location of the pump intake and discharge ports. Intake is on right when looking at pump end cover.
2. **DRIVE - DIRECT.**
3. **SELF-PRIMING** - Pump will produce a suction lift approaching 10 feet when dry and a lift up to 22 feet when primed. **BE SURE SUCTION LINES ARE AIRTIGHT** or pump will not self-prime.
4. **RUNNING DRY** - Unit depends on liquid pumped for lubrication. **DO NOT RUN DRY** for more than 30 seconds. Lack of liquid will damage impeller.
5. **NOTICE** - Do not pump solvents, thinners, highly concentrated organic acids. Impeller and pump damage may occur.  
If corrosive fluids must be handled, consult Jabsco Chemical Resistance Chart ( which is available upon request from Jabsco). Pump life will be prolonged if pump is flushed with water after each use or after each work day.
6. **PRESSURES** - For continuous operation, discharge pressure should not exceed 20 psi (1,4 kg/CM<sup>2</sup>).
7. **TEMPERATURES** - Nitrile impeller supplied in pump is recommended for liquid temperatures of 50° to 180°F (10° to 83°C).
8. **FREEZING WEATHER** - Drain unit by loosening the end cover.
9. To prevent run dry damage of the impeller, it is recommended that a Jabsco vacuum switch model 4732-0000 be installed.
10. **GASKET** - Use standard pump part. A thicker gasket will reduce priming ability. A thinner gasket will cause impeller to bind. Standard Gasket is 0.010" thick.
11. **SPARE PARTS** - A Jabsco Service Kit 90058-0003 should be kept on hand to service all but the most badly worn 6050 pumps.

### DISASSEMBLY

1. Remove end cover and end cover gasket.
2. Remove impeller.
3. Loosen cam screw and remove cam. Clean off sealant.
4. Remove wearplate with screwdriver or hooked wire.
5. Loosen nut at body clamp and remove body from motor.
6. Press out seal from motor mounting end of body towards impeller bore.
7. Slide O-ring off shaft.

**NOTE:** Inspect all parts for wear or damage and replace, if necessary. When returning pump to factory for repair, do not send motor unless it requires replacement. It is suggested that you contact local motor manufacturer's distributor for service.

### ASSEMBLY

1. Press seal into seal bore with lip facing toward the impeller bore.
2. Install wearplate, aligning slot with dowel pin in body.
3. Apply a thin coat of sealant to top of cam and cam screw threads. Install cam and secure with cam screw.
4. Lubricate impeller bore with water pump grease and install impeller in body. Use care not to damage seal lip with impeller sleeve.
5. Install gasket and end cover, securing with end cover screws.
6. Install O-ring on motor shaft and position 1/4" from motor boss.
7. Apply a liberal coating of grease to the O. D. of the motor shaft.
8. Align ding in impeller with shaft keyway and install on motor.
9. Secure nut at clamp. Do not overtighten.

Jabsco Pumps 6050-0001

[www.PumpAgents.com](http://www.PumpAgents.com) - Click here for Pricing/Ordering for Pumps and Parts

EXPLODED VIEW

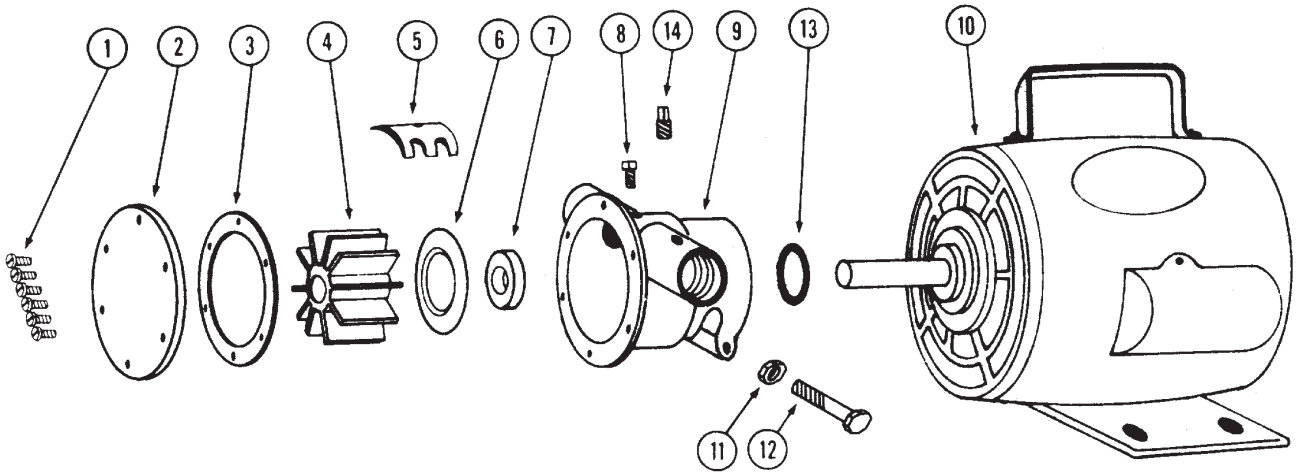

PARTS LISTS

Key	Part Number	Description	Qty. Req.
1	91003-0010	Screws (End Cover)	6
2	11831-0000	End Cover	1
3*	890-0000	Gasket	1
4*	6056-0003	Impeller Nitrile	1
	6056-0001	Impeller Neoprene (opt)	1
5	934-0000	Cam	1
6	4156-0010	Wearplate	1
7*	92700-0080	Seal	1
8	91004-0090	Screw (Cam)	1
9	6054-0000	Body	1
10	18736-0000	Motor (ODP)	1
	18738-0000	Motor (TEFC)	1
11	91105-0030	Nut (pump to motor bolt)	1
12	91095-0090	Bolt (pump to motor)	1
13	6398-0000	O-Ring	1
14	92650-0070	Plug	1
	90058-0001	Service Kit Neoprene	
	90058-0003	Service Kit Nitrile	
	6065-0003	Pump Head	

\* Included in Service Kit

## Jabsco Pumps 6050-0001

### TO EQUIP WITH VACUUM SWITCH

[www.PumpAgents.com](http://www.PumpAgents.com) - Click here for Pricing/Ordering for Pumps and Parts

1. Disconnect pump from power source.
2. Install vacuum switch (Jabsco model 4732-0000) in tapped hole on top of inlet port with nipple provided. (Seal threads prior to assembly.)
3. To connect switch to motor see Fig. 1. Remove cord from motor. Connect switch to motor terminals using length of cord supplied with switch. Connect cord to line terminals of switch, attach ground wire.
4. Plug into 110 Vac outlet and hold down restart lever on switch until the pump primes.

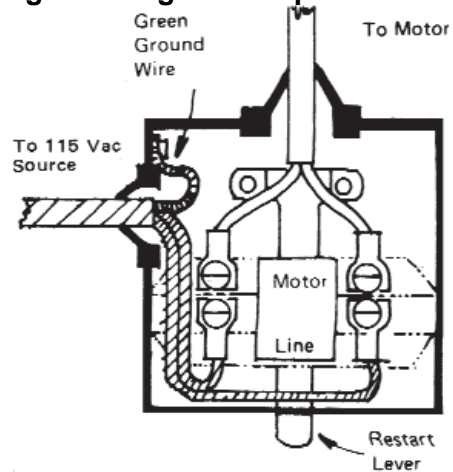

Fig. 1. Wiring Diagram for Vacuum Switch

### SPECIAL ATTENTION

1. Constant vibration of the vacuum switch's restart lever indicates:
  - (A) An air leak. This will usually show up when the pump is first started. All suction lines should be checked for loose connections.
  - (B) A worn impeller. Impeller should be replaced.
2. Intermittent stopping and starting of pump indicates that the unit is operating against excessive discharge pressure.

**WARNING** Explosion hazard. Switch is not ignition protected. Do not use in bilge area of vessels with gasoline engines or equipment as explosion can result causing injury or death.

### DIMENSIONAL DRAWING INCHES (millimetres)

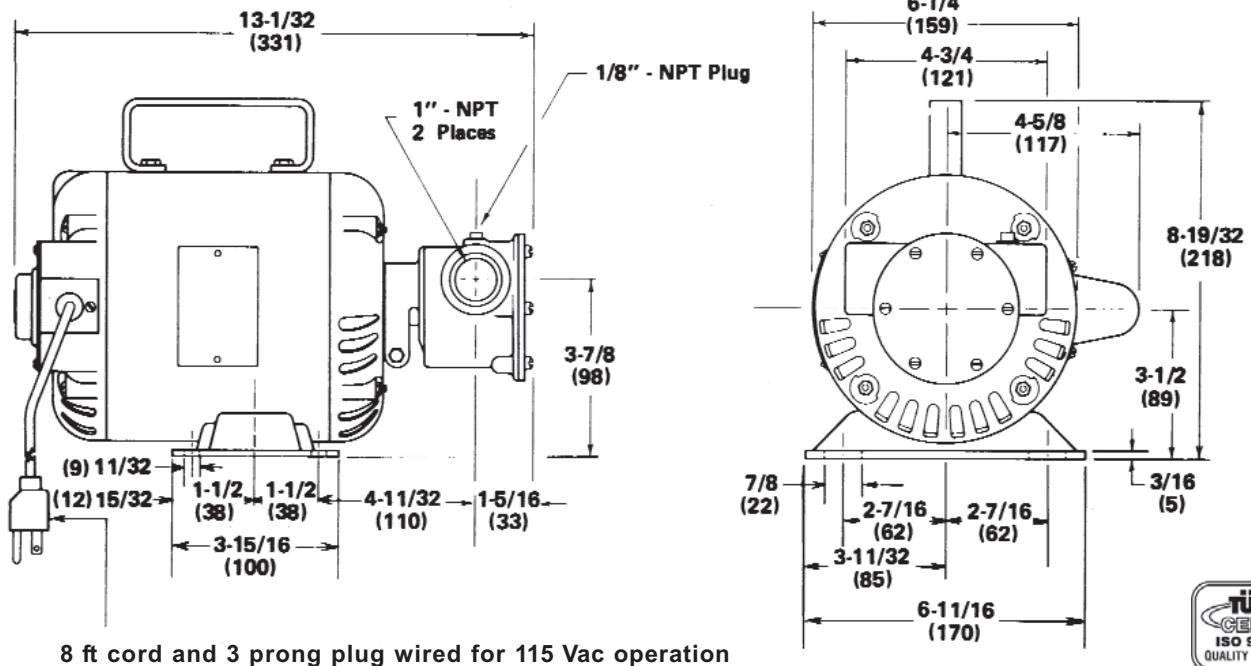

**xylem**  
Let's Solve Water

Jabsco, 1 Kondelin Road, Cape Ann Industrial Park, Gloucester, MA 01930  
Tel: +1 978 281 0440 Fax: +1 978 283 2619

USA

Jabsco, Bingley Road, Hoddesdon, Hertfordshire, EN11 0BU  
Tel: +44 (0) 1992 450 145 Fax: +44 (0) 1992 467 132

UK

NHK Jabsco Co Ltd, 3-21-10, Shin - Yokohama Kohoku-ku, Yokohama 222  
Tel: +81 (0) 45 475 8906 Fax: +81 (0) 45 475 8908

JAPAN

Jabsco GmbH, Ostraße 28, 22844 Norderstedt  
Tel: +49 (0) 40 53 53 73 0 Fax: +49 (0) 49 53 53 73 11

GERMANY

Jabsco Italia, s.r.l., Via Tommaseo, 6, 20059 Vimercate, Milano  
Tel: +39 039 685 2323 Fax: +39 039 666 307

ITALY

# FLEXIBLE IMPELLER PUMPS

Quality, Affordability, Reliability

Jabco Pumps 6050-9001  
www.PumpAgents.com - Click here for Pricing/Ordering for Pumps and Parts



## Principles of Flexible Impeller Pumps

### Features and Benefits

- Self priming.
- No need for a Pressure Relief Valve.
- Gentle pumping action gives excellent suspended solids handling capability.
- Pump can be mounted above or below the liquid source.
- Flow rate is exponentially linear to impeller speed.
- Capable of pumping across a wide range of viscosities.
- Can pump very abrasive media.
- Can pump foams, emulsions and gas enriched aqueous materials.
- Operates at high and low motor speeds.
- Will not airlock; continues to operate even when air passes through the system.
- Pumping is bi-directional due to the symmetry of the pump configuration.
- FIP pumps will pump out until the last drop of media has gone.
- FIP pumps have a low lifetime cost; few parts need to be replaced over its lifetime.
- Compact design still delivers high flow rates.

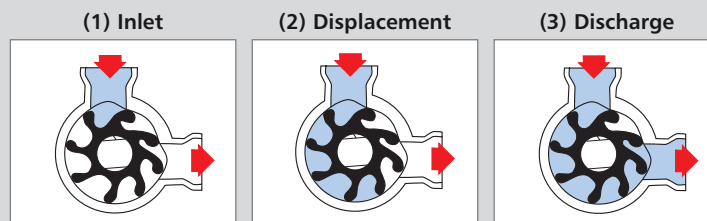

### How the FIP works

1. Flexible impeller blades create a partial vacuum for near instant dry self-priming.
2. As the impeller rotates, each successive blade draws in liquid and carries it from intake to outlet port.
3. As the flexible impeller blades contact the offset cam they bend with a gentle squeezing action that provides a continuous, pulsation free flow.

